

SPECIFICATIONS

DESCRIPTION

- Stainless steel filter housing
- Katadyne filter
- Flow regulated filtration for optimum performance
- Filters down to 0.2 microns
- Activated carbon core reduces chlorine, odour and bad taste
- Heavy metal removal

FLOW

- Recommended working pressure 0.5 bar/7.5PSI
- Maximum 5 bar/ 75 PSI
- 7L /min at 1 bar
- 13L /min at 3 bar

WARRANTY

- www.perrinandrowe.co.uk

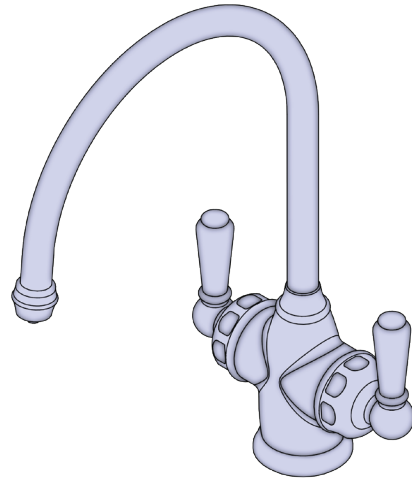

Sink Mixer with Filtration

MODELS: 1437

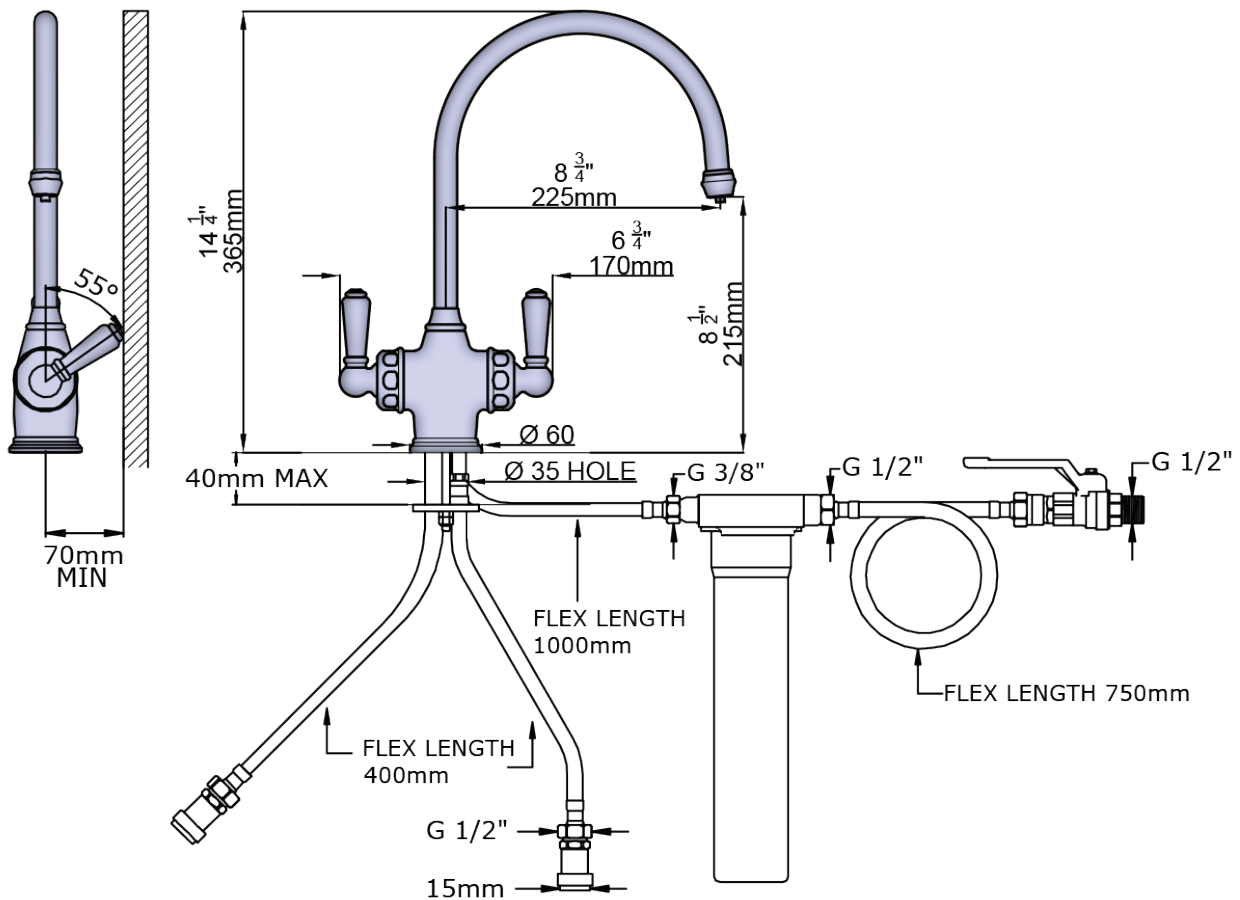

+44 (0) 1708 526 361

www.perrinandrowe.co.uk

A DISTINCTIVE MEMBER OF THE HOUSE OF ROHL