

## SPECIFICATIONS

### DESCRIPTION

- Flexible connectors for easier installation
- Supplied with 15mm double check valves

### FLOW

- Recommended working pressure 0.5 bar/7.5PSI
- Maximum 5 bar/ 75 PSI
- 8L /min at 0.5 bar
- 14L /min at 3 bar

### WARRANTY

- [www.perrinandrowe.co.uk](http://www.perrinandrowe.co.uk)

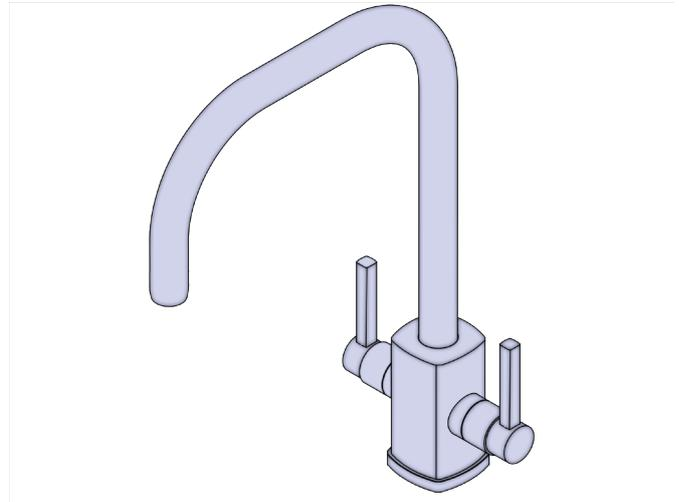

### Monobloc Sink Mixer

MODELS: 4210

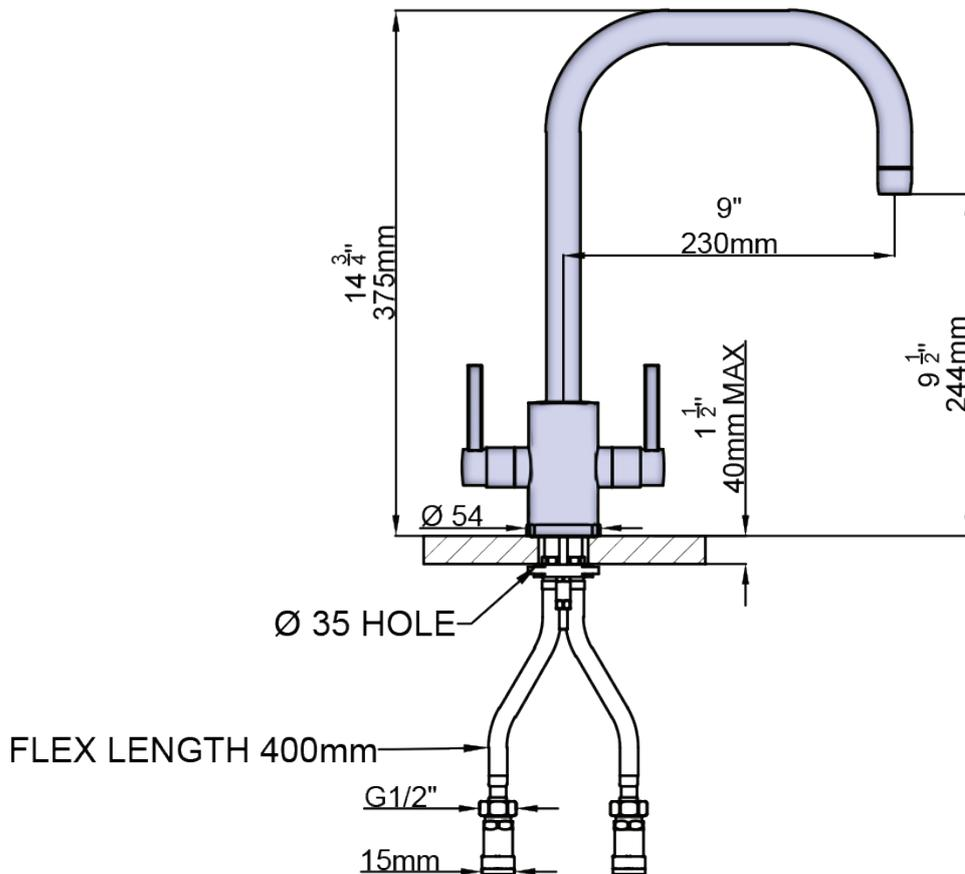

+44 (0) 1708 526 361

[www.perrinandrowe.co.uk](http://www.perrinandrowe.co.uk)

A DISTINCTIVE MEMBER OF THE HOUSE OF ROHL